

# SUMMER WAVES® ELITE FRAME POOL

FOR ABOVE GROUND SWIMMING POOLS

10' - 26' (3.05 m - 7.92 m) models



## READ AND KEEP THESE INSTRUCTIONS FOR FUTURE REFERENCE

For answers to common questions, setup videos and troubleshooting tips, please visit [support.polygroupstore.com](http://support.polygroupstore.com) or call Customer Service: +1 (888) 919-0070

**DO NOT RETURN PRODUCT TO STORE**



To order parts and accessories, please visit [www.polygroupstore.com](http://www.polygroupstore.com)



Should you encounter a problem with your Polygroup® Product, please DO NOT return the product to the place of purchase. All warranty claims must be made directly to Polygroup®. For any setup and troubleshooting issues, please visit [support.polygroupstore.com](http://support.polygroupstore.com). Customer Service: +1 (888) 919-0070. You may be asked to return all or part of the product for inspection and/or repair. Do not return any product to Polygroup® without a Return Merchandise Authorization number.

## TABLE OF CONTENTS

Warnings .....	3 ~ 6
Parts list .....	7 ~ 8
Setup instructions .....	9 ~ 11
Pool maintenance & drainage .....	12
Pool storage & winterizing .....	13
Pool safety sign .....	13
Pool cover safety.....	14

### Limited Warranty

Polygroup® Trading Limited (hereinafter “Polygroup®”) makes products at the best quality we are able to offer. All Polygroup® products have been inspected against defects in materials and workmanship prior to leaving factory. Polygroup® is happy to offer warranty for the repair or replacement of pool products for 90 days from the date of purchase. The provisions of this Limited Warranty only apply to the original purchaser. Please keep your original store sales receipt, as this proof of purchase will be required and must accompany warranty claims to Polygroup® or its designated agents. This Limited Warranty does not apply without proof of purchase; or should the purchaser modify or repair the product themselves or by unauthorized people; use non-Polygroup® parts or accessories with the product; use the product in contravention of the manufacturer’s instructions; use improper voltage; abuse the product in any way; or through accident or negligence. This Limited Warranty will not cover consequential damages, including claims for loss of water, pool chemicals, damage, or labor, normal wear-and-tear; nor acts of God outside the control of Polygroup®. Non-manufacturing defects, such as grasses that may grow through the ground cloth and/or pool liner are examples of which Polygroup® cannot be held responsible for.

IN NO EVENT SHALL Polygroup®, ITS AUTHORIZED AGENTS, RELATED ENTITIES, OR EMPLOYEES BE LIABLE TO THE BUYER OR ANY OTHER PARTY FOR DIRECT OR CONSEQUENTIAL DAMAGES. Some states or countries, or other jurisdictions, do not allow the exclusion or limitation of incidental or consequential damages, so the above limitation or exclusion may not apply to you.

This Limited Warranty is not extended to close-outs, factory seconds, or resold products (i.e. garage sales, online auctions, or online retailers not purchased directly from Polygroup®). Any issues with items purchased from these types of vendors / sellers will need to be addressed through these stores. Items purchased from seasonal stores will be treated with an “All Sales Final” Policy instead.

## IMPORTANT SAFETY INSTRUCTIONS

When installing and using this product, basic safety precautions should always be followed, including the following:

### READ AND FOLLOW ALL INFORMATION AND INSTRUCTIONS

Keep for future reference. Failure to follow these warnings and instructions can result in serious injury or death to users, especially children.

#### **WARNING**

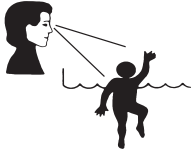

#### **DANGER**

##### **PREVENT DROWNING!**

CLOSELY WATCH CHILDREN WHO ARE IN OR NEAR THIS POOL. CHILDREN UNDER 5 ARE AT HIGHEST RISK FOR DROWNING. EMPTY POOL OR PREVENT ACCESS WHEN NOT IN USE.

**NO DIVING!**  
SHALLOW WATER!  
YOU CAN BREAK YOUR NECK AND BE PARALYZED.

#### **WARNING**

**DO NOT SIT ON OR LAY OVER POOL WALL**

**AVOID ENTRAPMENT!**  
STAY AWAY FROM DRAINS & SUCTION FITTINGS. YOUR HAIR, BODY & JEWELRY CAN GET SUCKED INTO DRAIN. YOU COULD BE HELD UNDER WATER & DROWN. DO NOT USE POOL IF DRAIN OR SUCTION OUTLET COVER IS MISSING OR BROKEN.



- Set up the pool only on **LEVEL, STABLE, and COMPACT** soil.
  - **DO NOT** set up the pool on sand surface.
  - Excessive sand inside the pool will **DAMAGE** the pool liner and filtration system.
- Failure to follow these instructions will void the warranty.

**NOTICE:** CUSTOMERS WHO PURCHASE POOLS MAY BE REQUIRED BY LOCAL OR STATE LAW TO INCUR ADDITIONAL EXPENSES WHEN INSTALLING A POOL, IN ORDER TO COMPLY WITH STATE OR LOCAL LAWS REGARDING FENCING AND OTHER SAFETY REQUIREMENTS. CUSTOMERS SHOULD CONTACT THEIR LOCAL BUILDING CODE ENFORCEMENT OFFICE FOR FURTHER DETAILS. POLYGROUP® IS NOT RESPONSIBLE FOR ANY ADDITIONAL EXPENSES THAT YOU MAY INCUR.

## Safety Care for Children

### Drowning Risk:

1. Assign an adult to be responsible for watching children in the pool. Give this person a "water watcher" tag and ask that they wear it the entire time they are in charge of supervising children in the pool. If they need to leave for any reason, ask this person to pass the "water watcher" tag and the supervision responsibility to another adult. **For replacement of the water watcher tag, please visit [www.polygroupstore.com](http://www.polygroupstore.com).**
2. Pool presents a drowning hazard even during filling and draining of the pool. Maintain constant supervision of children and do not remove any safety barriers until the pool is completely empty and stowed away.
3. Children, especially children younger than five years, are at high risk of drowning. Drowning occurs silently and quickly and can occur in as little as 2 in (5 cm) of water.
4. Keep children in your direct sight, stay close, and actively supervise them when they are in or near this pool and when you are filling and emptying this pool.
5. When searching for a missing child, check the pool first, even if child is thought to be in the house.
6. Do not leave toys inside pool when finished using, since toys and similar items might attract a child to the pool. Position furniture (for example, tables, chairs) away from pool, so that children cannot climb on it to gain access to the pool. After using pool, remove water to a level of ½ in (1 cm) or less.
7. Locate pumps and filters in such a way that children cannot climb on them and gain access to the pool.

## Swimming Pool Barriers

### Very Important:

1. Swimming pool barriers, which restrict access to the pool by small children, may be required by law. A barrier is necessary to provide protection against potential drowning and near drowning. Barriers are not a substitute for constant supervision of children.
2. Keep unsupervised children from accessing the pool by installing fencing or other approved barrier around all sides of pool. State or local laws or codes may require fencing or other approved barriers. Check state or local laws and codes before setting up pool.
3. See latest published edition of CPSC Pub. No. 362 found at [www.poolsafely.gov](http://www.poolsafely.gov).

## Swimming Pool Equipment

1. The use of artificial pool lighting is at the discretion of the pool owner. Lighting, when installed, should be in accordance with Article 680 of the National Electrical Code (NEC®) or its latest approved edition and in consultation with a licensed electrical professional.
2. Keep all electrical lines, radios, speakers, and other electrical appliances away from the pool.
3. Do not place pool near or under overhead electrical lines.
4. For swimming pools, fountains, and similar installations, and any state or local code, all electrical components installed in and/or adjacent to an above-ground/on-ground residential swimming pool shall be installed in accordance with and shall comply with the requirements of the latest published edition of NFPA 70, National Electrical Code (NEC®) Article 680. For more information, visit [www.nfpa.org](http://www.nfpa.org).

## Swimming Pool Awareness

### Warning :

1. **ADULT ASSEMBLY REQUIRED:** This pool may contain potentially hazardous sharp edges, sharp points, or small parts.
2. **Do not install the pool on a slope or inclined surfaces, on soft or loose soil conditions (such as sand or mud), or on an elevated surface such as a deck, platform or balcony. It may collapse under the weight of the filled pool.**
3. **TO AVOID DANGER OF SUFFOCATION:** Keep the plastic bag used in this product away from babies and children; do not use the bag in cribs, beds, carriages, or playpens. The plastic bag could block the nose and mouth and prevent breathing. The plastic bag is not a toy.
4. If a drain or suction outlet cover is missing or broken, do not use the pool. Suction can cause body part entrapment, hair and jewellery entanglement, or drowning. Repair or replace the drain or suction outlet cover before using the pool again.
5. When using the pool at night, artificial lighting should be used to illuminate all safety signs, ladders, steps, deck surfaces, and pathways.
6. The floor of the pool shall be visible at all times from the outside perimeter of the pool.
7. Keep your pool clean and clear. The deepest part of pool must be visible at all times from outside of the pool.
8. Call for emergency if needed.
9. Basic lifesaving equipment, including one of the following, should be on hand at all times:
  - A light, strong, rigid pole (shepherd's crook) not less than 12' [3.66 m] long.
  - A ¼" [6.35 mm] diameter rope as long as one and one half (1 ½) times the maximum width of the pool or 50' [15.24 m], whichever is less, which has been firmly attached to a Coast Guard-approved ring buoy having an outside diameter of approximately 15" [38.1 cm], or similarly approved flotation device.
10. The pool is subject to wear and deterioration. If not maintained properly, certain types of excessive or accelerated deterioration can lead to a failure of the pool structure that might release large quantities of water that could cause bodily harm and property damage.
11. Never allow fooling around, diving, or jumping into or around the pool. This could lead to serious injury, paralysis or death.  
DO NOT ALLOW anyone to swim alone without supervision.
12. Pool shall be located at a minimum distance of 6 ft (1.83 m) from any receptacle, and all 125-volt 15- and 20-ampere receptacles located within 20 ft (6.0 m) of the pool shall be protected by a ground fault circuit interrupter (GFCI), where distances are by measuring the shortest path the supply cord of an appliance connected to the receptacle would follow, without piercing a floor, wall, ceiling, doorway with hinged or sliding door, window opening, or other effective permanent barrier, to the inside wall of the pool.

## Circulation Systems

1. Follow written instructions regarding positioning of all equipment connected to the circulation systems and operating the components.
2. Circulation equipment should be installed per manufacturer's instructions to provide proper mounting and support, to prevent damage from misalignment, settlement, and vibration, and to minimise the potential for the accumulation of debris and moisture. Please refer to pump's instruction manual.
3. A replacement pump should never exceed the maximum flow rate marked on the suction fitting.

## Ladder

1. The ladder should be located on a solid base and is to be installed per the manufacturer's instructions.
2. One person on the ladder at a time.
3. This ladder is designed and manufactured for a specific pool wall height and/or deck of the pool.
4. When entering/exiting the pool, face the ladder at all times.
5. To prevent entrapment or drowning do not swim through, behind, or around the ladder.
6. Remove and secure the ladder when pool is not occupied.

## Pool Cover

Pool covers used for safety barriers shall comply with the latest published edition of ASTM F-1346, Standard performance specifications for safety covers and labeling requirements for all covers for swimming pools, spas, and hot tubs.

## Chemicals

For safety's sake, ensure the deepest part of the pool is always visible. The user must properly maintain pool water clarity at all times. Check the pH and chlorine levels periodically, and make sure they are within the recommended limits. Additional water treatment chemicals might be needed from time to time. Have the water sample tested by a local pool supply store to determine if additional chemicals are needed. Turn on the pump for the recommended hours daily. If you are unsure of the time frames please refer to [support.polygroupstore.com](http://support.polygroupstore.com) for the recommended Pump Operation Hours based on pool types and sizes. Clean and replace filter cartridge frequently. Replace only with genuine Polygroup®/Summer Waves® Brand filter cartridges. Refer to the Filter Pump manual for additional water care information.

## Risk of Entrapment

1. Entrapment Avoidance: There shall be no protrusions or obstruction in the swimming area, which may cause entrapment or entanglement of the user. If a suction outlet cover is missing or broken, do not use the pool. Suction can cause body part entrapment, hair and jewelry entanglement, evisceration, or drowning. Repair or replace the suction outlet cover before allowing the pool to be used.
2. Never play or swim near drains or suction fittings. Your body or hair may be trapped, causing permanent injury or drowning.

## Risk of Drowning

1. Keep unsupervised children from accessing the pool by installing fencing or other approved barriers around all sides of pool. State or local laws or codes may require fencing or other approved barriers. Check state or local laws and codes before setting up the pool.
2. Remove pool ladders after leaving the pool.
3. Toys, chairs, tables, or similar objects that a young child could climb should be at least four feet (4') [121.92 cm] from the pool. The pump filter system should be positioned so as to prevent it from being used as a means of access to the pool by young children.

## Diving Risk

1. Above-ground/on-ground residential swimming pools are for swimming and wading only. No diving boards, slides, or other equipment are to be added to an above-ground/on-ground pool.
2. Do not dive into this pool. Diving into shallow water can result in a broken neck, paralysis, or death.

## Risk of Electrocutation

1. Keep all electrical lines, radios, speakers, and other electrical appliances away from the pool.
2. Do not place the pool near or under overhead electrical lines.

## First Aid

1. Keep a working phone and a list of emergency numbers near the pool.
2. Become certified in cardiopulmonary resuscitation (CPR). In the event of an emergency, immediate use of CPR can make a lifesaving difference.

## Special Warning

1. Local building codes may require obtaining a building or electrical permit. The installer shall follow regulations on setback, barriers, devices, and other conditions.
2. Safety signs shall comply with requirements of ANSI-Z535 and use signal wording.
3. DO NOT attempt to assemble this pool in adverse weather conditions, windy conditions, or when the temperature is below 60°F.
4. This is a storable pool, which should be disassembled and stored when temperatures are expected to fall below 32°F.
5. Ensure that all pools and their related components that are installed in an indoor environment should comply with the ventilation requirements of ANSI/ASHRAE 62 or the latest published edition of Ventilation for acceptable indoor air quality, Table 2, Article 2.1.
6. The placement of the pool and portable pools shall be set up so that they comply with local safety and building codes.

## Extra Safety Warning

1. When you touch the filter, pump, or electrical parts, be sure the ground under your feet is "Bone Dry."
2. Connect power cords to a 3-wire grounding-type outlet only.
3. Keep all breakable objects out of the pool area.
4. Alcohol consumption and pool activities do not mix. Never allow anyone to swim, dive, or slide while under the influence of alcohol or drugs.
5. Severe electrical shock could result if you install your filter pump on a deck. The pump or filter could fall into the water, causing severe shock or electrocution.
6. Do not allow roughhousing and fooling around
7. Do not engage in extended breath holding activities underwater; you may black out and drown.
8. Install pool ladder(s) or a staircase for entry and exit from the pool.
9. Check regularly for signs of wear on the liner or any loose parts that could make the pool unsafe.
10. Instruct pool users about the proper use of all pool ladder(s) and staircases.
11. Check all nuts and bolts regularly to ensure that the ladder stays sturdy.
12. Please contact pool site dealer or manufacturer for additional safety signs if deemed necessary.
13. For pool service, choose a certified pool professional. For additional safety information, see [www.APSP.org](http://www.APSP.org)

## Consumer Awareness Booklets and Information Source

**CONTACT:** U.S. Consumer Product Safety Commission at [www.cpsc.gov/safety-education/safety-guides/pools-and-spas](http://www.cpsc.gov/safety-education/safety-guides/pools-and-spas), Pub. #362 "Safety Barrier Guidelines for Home Pools."

1. The Sensible Way to Enjoy Your Above-ground/On-ground Swimming Pool.
2. Children Aren't Waterproof.
3. Layers of Protection.
4. Pool and Spa Emergency Procedures for Infants and Children.
5. Be Safety Aware Copies of the above brochures are available free from the APSP. Go to: [www.APSP.org](http://www.APSP.org)



## Safety Education Programs and Materials

Educational programs and materials (i.e., seminars, workshops, brochures, videos, instructional guides) are available from the APSP, other aquatic safety groups, and by private firms. As a means of communicating useful safety information to pool owners/operators and users, industry members are permitted to provide such information to owners/operators and to request or require owners/operators to sign a statement that they have received, read, and will follow the guidelines.

### Other sources of safety information:

- [www.cdc.gov](http://www.cdc.gov)
- [www.cpsc.gov](http://www.cpsc.gov)
- [www.drowningpreventionalliance.com](http://www.drowningpreventionalliance.com)
- [www.nspf.org](http://www.nspf.org)
- [www.safekids.org](http://www.safekids.org)

### NSF NSF International

P.O. Box 130140  
789 N. Dixboro Road  
Ann Arbor MI 481105  
Contact: 800-673-6275 or 734-769-8010  
[www.nsf.org](http://www.nsf.org)

### ANSI American National Standards Institute

25 West 43rd Street, New York NY 10036  
Contact: 212-642-4900  
[www.ansi.org](http://www.ansi.org)

### ASTM ASTM International (formerly American Society of Testing & Materials)

100 Barr Harbor Drive, P.O. Box C700 West Conshohocken, PA 19428-2959  
Contact: 877-909-2786 (USA & CANADA) or 610-832-9585 (International)  
[www.astm.org](http://www.astm.org)

### APSP Association of Pool & Spa Professionals

(formerly National Spa and Pool Institute)  
2111 Eisenhower Avenue, Ste. 500  
Alexandria VA 22314-4679  
Contact: 703-838-0083  
[www.apsp.org](http://www.apsp.org)

### NEC National Electrical Code (see NFPA)

NFPA National Fire Protection Association  
1 Batterymarch Park, Quincy MA 02169-7471  
Contact: 800-344-3555 (U.S. & CANADA) or 617-770-3000 (International)  
[www.nfpa.org](http://www.nfpa.org)

### NSPI National Spa and Pool Institute (see APSP)

### UL Underwriters Laboratories

333 Pfingsten Road, Northbrook IL 60062-2096  
Contact: 877-854-3577 or 847-272-8800  
[www.ul.com](http://www.ul.com)

### ASME American Society of Mechanical Engineers

Two Park Avenue, New York NY 10016-5990  
Contact: 800-843-2763 (U.S. & CANADA) or 973-882-1170 (Outside N. America)  
[www.asme.org](http://www.asme.org)

## Filtration Systems

Any equipment connected to the circulation systems shall be positioned so as to prevent their being used as a means of access to the pool by young children. (See the latest published edition of ANSI/APSP-8 Model Barrier Code for Residential Swimming Pools, Spas, and Hot Tubs.)

## Barrier

Barrier is necessary to provide protection against potential drowning and near drowning, and barriers are not a substitute for the constant supervision of children. (See latest published edition of ANSI/APSP-8 Model Barrier Code for Residential Swimming Pools, Spas, and Hot Tubs.)

## Risk of Drowning, Entrapment, and Diving Accidents

Publications are available that describe the risk of drowning, entrapment, and diving accidents. Available publications related to pool safety include the Association of Pool and Spa Professionals' (APSP) booklets entitled: The Sensible Way to Enjoy Your Above-ground/On-ground Swimming Pool, Children Aren't Waterproof, Pool and Spa Emergency Procedures for Infants and Children, Layers of Protection, and the latest published edition of ANSI/APSP-8 Model Barrier Code for Residential Swimming Pools, Spas, and Hot Tubs.







## Installer Responsibilities

All of these components shall be positioned so as to prevent their being used as a means of access to the pool by young children. All safety signs shall be affixed above the water line according to manufacturer's instructions. (See the latest published edition of ANSI/APSP-8 Model Barrier Code for Residential Swimming Pools, Spas, and Hot Tubs.)

## PARTS LIST

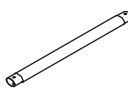
	<b>1</b>			<b>2</b>		<b>3</b>		<b>4</b>		<b>5</b>		<b>6</b>		<b>7</b>		<b>8</b>		
Elite Frame Pool	Pool Liner			Horizontal Beam		Vertical Leg		T-Fitting		EZ-Link T-Fitting		Leg Cap		Pin & Grommet (with 2 extra)		Pre-installed V-Shaped Spring Pin (with 1 extra)		
Pool Size	Part #			Qty.	Part #	Qty.	Part #	Qty.	Part #	Qty.	Part #	Qty.	Part #	Qty.	Part #	Qty.	Part #	Qty.
12'x48" (366x122) cm	P40012481099	P40012487099	P40012488099	1	P5A1B0002C01	12	P5A2B0007C01	12	P5A3B0012C01	11	P5A3B2012C01	1	P5APF5910K01	P5A593144E01	P5APF5920E01	12	24	12
14'x42" (427x107) cm	P40014421099	P40014427099	P40014428099	1	P5A1B0002C01	14	P5A2C0003C01	14	P5A3B0011C01	13	P5A3B2011C01	1				14	28	14
15'x42" (457x107) cm	P40015421099	P40015427099	P40015428099	1	P5A1B0002C01	15	P5A2C0003C01	15	P5A3B0002C01	14	P5A3B2002C01	1				15	30	15
15'x48" (457x122) cm	P40015481099	P40015487099	P40015488099	1	P5A1B0002C01	15	P5A2B0002C01	15	P5A3B0002C01	14	P5A3B2002C01	1				15	30	15
16'x42" (488x107) cm	P40016421099	P40016427099	P40016428099	1	P5A1B0002C01	16	P5A2C0006C01	16	P5A3B0003C01	15	P5A3B2003C01	1				16	32	16
16'x48" (488x122) cm	P40016481099	P40016487099	P40016488099	1	P5A1B0002C01	16	P5A2B0002C01	16	P5A3B0003C01	15	P5A3B2003C01	1				16	32	16
17'x48" (518x122) cm	P40017481099	P40017487099	P40017488099	1	P5A1B0002C01	17	P5A2B0002C01	17	P5A3B0004C01	16	P5A3B2004C01	1				17	34	17
18'x48" (549x122) cm	P40018481099	P40018487099	P40018488099	1	P5A1B0002C01	18	P5A2B0002C01	18	P5A3B0005C01	17	P5A3B2005C01	1				18	36	18
18'x52" (549x132) cm	P40018521099	P40018527099	P40018528099	1	P5A1B0002C01	18	P5A2B0003C01	18	P5A3B0005C01	17	P5A3B2005C01	1				18	36	18
20'x48" (610x122) cm	P40020481099	P40020487099	P40020488099	1	P5A1B0002C01	20	P5A2B0002C01	20	P5A3B0006C01	19	P5A3B2006C01	1				20	40	20
22'x52" (671x132) cm	P40022521099	P40022527099	P40022528099	1	P5A1B0001C01	22	P5A2B0003C01	22	P5A3B0007C01	21	P5A3B2007C01	1				22	44	22
24'x48" (732x122) cm	P40024481099	P40024487099	P40024488099	1	P5A1B0001C01	24	P5A2B0002C01	24	P5A3B0008C01	23	P5A3B2008C01	1				24	48	24
24'x52" (732x132) cm	P40024521099	P40024527099	P40024528099	1	P5A1B0001C01	24	P5A2B0003C01	24	P5A3B0008C01	23	P5A3B2008C01	1	24	48	24			
26'x52" (792x132) cm	P40026521099	P40026527099	P40026528099	1	P5A1B0001C01	26	P5A2B0003C01	26	P5A3B0009C01	25	P5A3B2009C01	1	26	52	26			

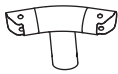
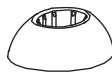
# PARTS LIST

																			
Elite Frame Pool		Pool Liner (Wicker Print)		Horizontal Beam		Vertical Leg		T-Fitting		EZ-Link T-Fitting		Leg Cap		Pin & Grommet (with 2 extra)		Pre-installed V-Shaped Spring Pin (with 1 extra)			
Pool Size	Part #			Qty.	Part #	Qty.	Part #	Qty.	Part #	Qty.	Part #	Qty.	Part #	Qty.	Part #	Qty.	Part #	Qty.	
14'x42" (427x107) cm	P4A014422099	P4A014424099	P4A014428099	1	P5A1B0002E0K	14	P5A2C0003E0K	14	P5A3B0011E0K	13	P5A3B2011E0K	1	P5APF59107CN	14	P5A5931447CN	28	P5APF59207CN	14	
14'x42" (427x107) cm	P4W014422099	P4W014424099	P4W014428099	1	P5A1B0002E0N	14	P5A2C0003E0N	14	P5A3B0011E0N	13	P5A3B2011E0N	1	P5APF59108UN	14	P5A5931448UN	28	P5APF59208UN	14	
14'x42" (427x107) cm	P40014422099	P40014424099	P40014428099																
14'x42" (427x107) cm	P4J014421099	P4J014427099	P4J014428099																
14'x42" (427x107) cm	P4N014421099	P4N014427099	P4N014428099																
14'x42" (427x107) cm	P4W014423099	--	--	1	P5A1B0002C01	14	P5A2C0003C01	14	P5A3B0011C01	13	P5A3B2011C01	1	P5APF5910C01	14	P5A593144C01	28	P5APF5920C01	14	
15'x42" (457x107) cm	P4A015421099	P4A015427099	P4A015428099	1	P5A1B0002E0K	15	P5A2C0003E0K	15	P5A3B0002E0K	14	P5A3B2002E0K	1	P5APF59107CN	15	P5A5931447CN	30	P5APF59207CN	15	
15'x48" (457x122) cm	P40015482099	P40015484099	P4B015482099	1	P5A1B0002E0N	15	P5A2B0002E0N	15	P5A3B0002E0N	14	P5A3B2002E0N	1	P5APF59108UN	15	P5A5931448UN	30	P5APF59208UN	15	
15'x48" (457x122) cm	P40015485099	P4A015484099	P4A015485099	1	P5A1B0002E0K	15	P5A2B0002E0K	15	P5A3B0002E0K	14	P5A3B2002E0K	1	P5APF59107CN	15	P5A5931447CN	30	P5APF59207CN	15	
16'x48" (488x122) cm	P40016485099	P4A016484099	P4A016482099	1	P5A1B0002E0K	16	P5A2B0002E0K	16	P5A3B0003E0K	15	P5A3B2003E0K	1	P5APF59107CN	16	P5A5931447CN	32	P5APF59207CN	16	
16'x48" (488x122) cm	P40016485099	--	--	1	P5A1B0002E0N	16	P5A2B0002E0N	16	P5A3B0003E0N	15	P5A3B2003E0N	1	P5APF59108UN	16	P5A5931448UN	32	P5APF59208UN	16	
16'x48" (488x122) cm	P40016482099	P40016484099	P4B016482099																
16'x48" (488x122) cm	P4G016482099	P4G016484099	P4G016483099																
16'x48" (488x122) cm	P4J016482099	P4J016484099	P4J016483099																
16'x48" (488x122) cm	P4N016482099	P4N016484099	P4N016483099	1	P5A1B0002C01	16	P5A2B0002C01	16	P5A3B0003C01	15	P5A3B2003C01	1	P5APF5910C01	16	P5A593144C01	32	P5APF5920C01	16	
16'x48" (549x122) cm	P4D016482099	P4D016484099	P4D016483099																
16'x48" (549x122) cm	P4W016482099	P4W016484099	P4W016483099																
16'x48" (549x122) cm	P4Q016482099	P4Q016484099	P4Q016483099																
18'x48" (549x122) cm	P40018485099	P4A018484099	P4A018482099	1	P5A1B0002E0K	18	P5A2B0002E0K	18	P5A3B0005E0K	17	P5A3B2005E0K	1	P5APF59107CN	18	P5A5931447CN	36	P5APF59207CN	18	
18'x48" (549x122) cm	P40018485099	--	--	1	P5A1B0002E0N	18	P5A2B0002E0N	18	P5A3B0005E0N	17	P5A3B2005E0N	1	P5APF59108UN	18	P5A5931448UN	36	P5APF59208UN	18	
18'x48" (549x122) cm	P40018483099	P40018484099	P4B018483099																
18'x48" (549x122) cm	P4G018482099	P4G018484099	P4G018483099																
18'x48" (549x122) cm	P4J018482099	P4J018484099	P4J018483099																
18'x48" (549x122) cm	P4Q018482099	P4Q018484099	P4Q018483099	1	P5A1B0002C01	18	P5A2B0002C01	18	P5A3B0005C01	17	P5A3B2005C01	1	P5APF5910C01	18	P5A593144C01	36	P5APF5920C01	18	
18'x48" (549x122) cm	P4N018482099	P4N018484099	P4N018483099																
18'x48" (549x122) cm	P4W018482099	P4W018484099	P4W018483099																
18'x48" (549x122) cm	P4Q018482099	P4Q018484099	P4Q018483099																
18'x52" (549x132) cm	P40018525099	P4A018525099	P4A018522099	1	P5A1B0002E0K	18	P5A2B0003E0K	18	P5A3B0005E0K	17	P5A3B2005E0K	1	P5APF59107CN	18	P5A5931447CN	36	P5APF59207CN	18	
18'x52" (549x132) cm	P4B018522099	P4B018524099	P4B018523099	1	P5A1B0002E0N	18	P5A2B0003E0N	18	P5A3B0005E0N	17	P5A3B2005E0N	1	P5APF59108UN	18	P5A5931448UN	36	P5APF59208UN	18	
18'x52" (549x132) cm	P4J018522099	P4J018524099	P4J018523099																
18'x52" (549x132) cm	--	P4G018523099	--																
18'x52" (549x132) cm	P4N018521099	P4N018527099	P4N018528099																
20'x48" (610x122) cm	P40020485099	P4A020484099	P4A020482099	1	P5A1B0002E0K	20	P5A2B0002E0K	20	P5A3B0006E0K	19	P5A3B2006E0K	1	P5APF59107CN	20	P5A5931447CN	40	P5APF59207CN	20	
20'x48" (610x122) cm	P4G020483099	P4G020484099	P4G020482099	1	P5A1B0002E0N	20	P5A2B0002E0N	20	P5A3B0006E0N	19	P5A3B2006E0N	1	P5APF59108UN	20	P5A5931448UN	40	P5APF59208UN	20	
20'x48" (610x122) cm	P4J020485099	P4J020484099	P4J020483099																
20'x48" (610x122) cm	P4B020482099	P4B020484099	P4B020483099																
20'x48" (610x122) cm	P4T020482099	P4T020484099	P4T020483099																
20'x48" (610x122) cm	P4N020481099	P4N020487099	P4N020488099	1	P5A1B0001E0K	22	P5A2B0003E0K	22	P5A3B0007E0K	21	P5A3B2007E0K	1	P5APF59107CN	22	P5A5931447CN	44	P5APF59207CN	22	
22'x52" (671x132) cm	P40022525099	P4A022524099	P4A022522099																
22'x52" (671x132) cm	P4J022523099	P4J022524099	P4J022522099																
22'x52" (671x132) cm	P4B022525099	P4B022524099	P4B022522099																
22'x52" (671x132) cm	--	--	P4Q022522099	1	P5A1B0001E0N	22	P5A2B0003E0N	22	P5A3B0007E0N	21	P5A3B2007E0N	1	P5APF59108UN	22	P5A5931448UN	44	P5APF59208UN	22	
22'x52" (671x132) cm	P4N022523099	P4N022524099	P4N022522099																
24'x52" (732x132) cm	P40024525099	P4A024524099	P4A024522099																
24'x52" (732x132) cm	P40024522099	P40024524099	P4B024522099																
24'x52" (732x132) cm	P4G024522099	P4G024524099	P4G024523099	1	P5A1B0001E0N	24	P5A2C0003E0N	24	P5A3B0008E0N	23	P5A3B2008E0N	1	P5APF59108UN	24	P5A5931448UN	48	P5APF59208UN	24	
24'x52" (732x132) cm	P4J024522099	P4J024524099	P4J024523099																
24'x52" (732x132) cm	P4N024522099	P4N024524099	P4N024523099																
24'x52" (732x132) cm	P40026522099	P40026524099	P4B026522099																
26'x52" (792x132) cm	P40026522099	P40026524099	P4B026522099	1	P5A1B0001E0N	26	P5A2B0003E0N	26	P5A3B0009E0N	25	P5A3B2012E0N	1	P5APF59108UN	26	P5A5931448UN	52	P5APF59208UN	26	



## SETUP INSTRUCTIONS

Before assembling your product, please take a few minutes to check the contents and become familiar with all the parts.

**WARNING** - DO NOT overfill the pool and / or allow people to lay over or sit on pool wall - DOING SO CAN CAUSE PERMANENT INJURY!  
DRAIN pool to the proper level after a heavy rain.

**TIP:** It will be much easier to install your pool if you unfold it and let it lay in direct sunlight for about 2 hours prior to installation. This will help to ensure a wrinkle-free fit because the pool material will be more pliable allowing it to form into shape during installation.

**WARNING** - VERY IMPORTANT! SITE MUST BE LEVEL, STABLE, COMPACTED SOIL.

- The pool must be assembled on a smooth and level site of firm soil that is free of stones, gravel, sticks, blacktop, or other oil base compounds.
- Before setting up your pool, it is recommended that you clear the area of hardy grasses. Certain types of vigorous grasses such as St. Augustine and Bermuda can grow through the liner. A ground cloth or tarp may be helpful in preventing this from occurring. Grass growing through the liner is not covered under warranty.
- Do not install pool on a wooden deck or any type of wooden surface. You cannot use sand and/or uncompacted soil to provide a level surface for this pool; it will only wash out.
- FAILURE TO FOLLOW ALL OF THESE INSTRUCTIONS WILL CAUSE POOL TO COLLAPSE AND WILL VOID THE WARRANTY!

### Site Preparation

1. Select a level area, and completely remove all debris, twigs, stones, etc. DO NOT select an area under overhead electrical lines, trees, or within 15 feet of a house, building, etc.
2. The pool shall be located a minimum distance of 6ft (1.83m) from any electrical receptacle.
3. All 125 volt, 15 and 20 ampere receptacles located within 20ft (6.0m) of the pool shall be protected by a ground fault circuit interrupter (GFCI).  
The 20ft (6m) distance is measured via the shortest straight line distance the supply cord would follow without piercing a floor, wall, ceiling, doorway, window, or other permanent barrier.
4. Contact your local utilities, checking that no underground cables, telephone lines, gas lines, etc. run beneath the area you have selected.

### Setup Instructions

1. Locate a level and flat area to set up the pool. Make sure the ground is free from sharp objects as they may puncture the pool.
2. Carefully unfold the pool liner in the area selected and inspect the seams for manufacturing defects.
3. It is recommended to let the pool sit out in direct sunlight for about 2 hours prior to installation (see TIP above).
4. LIFT the pool liner across the ground. DO NOT drag the liner from one location to another location.
5. Locate the pool so that the pump opening is 10 to 21 feet away from the electrical outlet.

6. Insert the Vertical Legs **3** into the Leg Caps **6**.

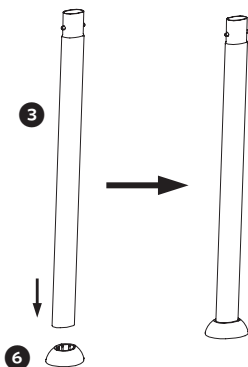

7. Lay all parts on the ground as shown below.

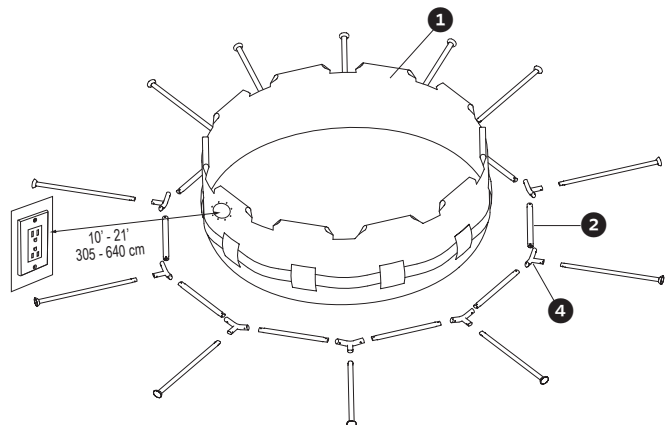

\* Image for reference only

8. Carefully slide the Horizontal Beams **2** into the sleeves of the pool.

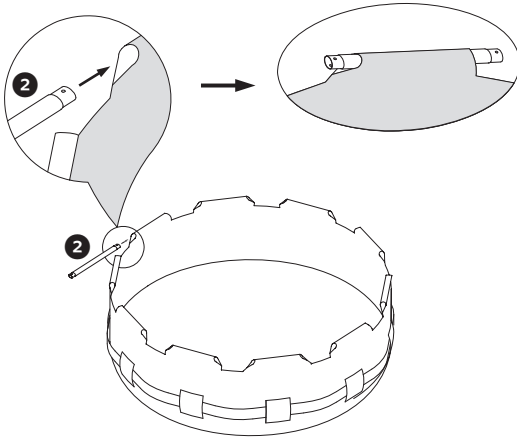

9. Connect the T-Fitting **4** to the Horizontal Beam **2**.  
**IMPORTANT:** Connect all T-Fittings to all Horizontal Beams. BUT reserve a space for EZ Link T-Fitting **5**.

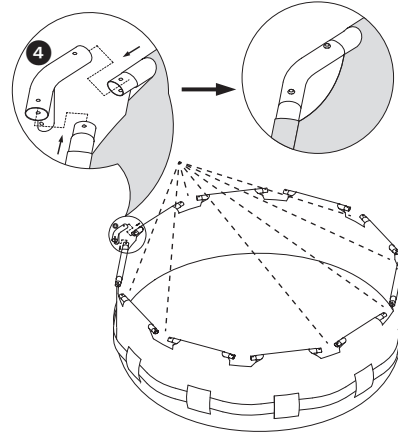

10. Connect the EZ Link T-Fitting **5** to the last remaining Horizontal Beams **2**.

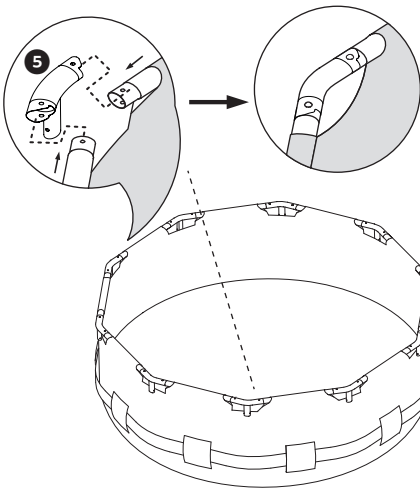

11. Insert the Pins **7** down through the top of the T-Fittings until the Pins snap into place on the lower side of the T-fitting.

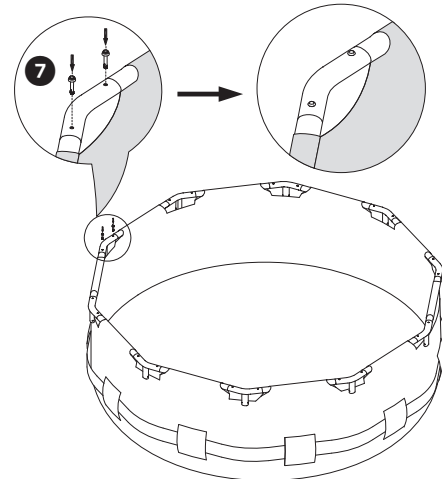

12. Carefully slide the Vertical Legs **3** up through the belt that runs around the middle of the pool.

**Tips:** For smaller pools without a belt, slide the vertical legs up through the sleeves on the pool wall.

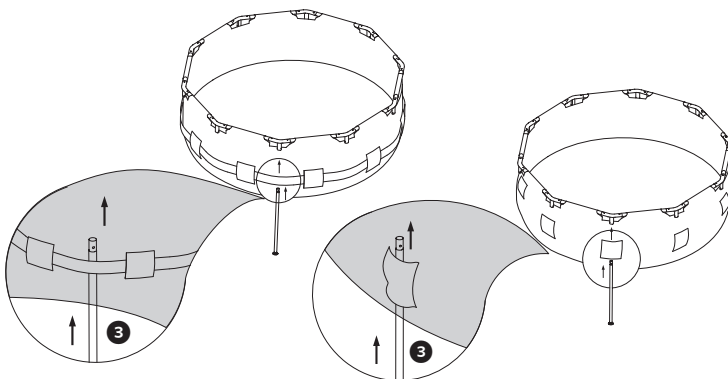

13. Look through the hole in the T-fitting, as you insert the Vertical Leg rotate it until the buttons align with the holes and pop out, locking the Vertical Leg in place. Do this for all Vertical Legs.

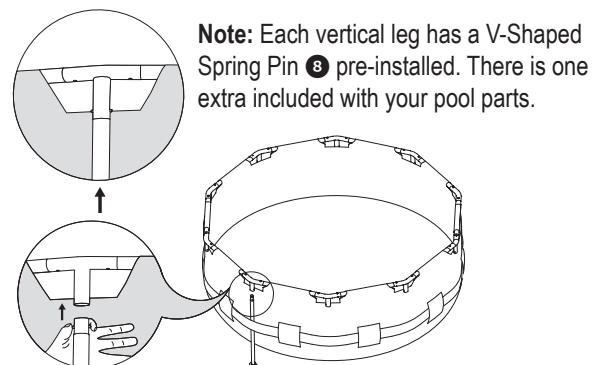

14. Go around and check all fittings, legs, and beams are properly installed and secured in place. Make sure the drain fitting is plugged securely and the cap is in place.

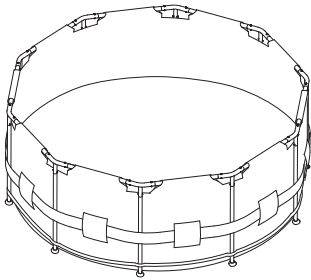

15. Fill up the pool with about an inch (1") [2.54cm] of water. Stop filling and smooth out all wrinkles from the pool floor, working outwards from the center, so that it fills evenly.

**Note:** If more than one to two inches (1"-2") [2.54cm-5.08cm] of water collects on any one side before the pool starts filling in the center, the pool is not level enough, and must be corrected.

16. Install the filtration system as per its instruction manual.  
17. Continue to fill the pool to approximately eight inches (8") [20.32cm] below the top rim.

**NOT FOLLOWING THE STEPS ABOVE WILL MAKE THE POOL FILL UNEVENLY AND THE POOL MAY LEAN TO ONE SIDE AND COLLAPSE (SEE PICTURE). YOUR POOL SHOULD BE STRAIGHT AND VERTICAL TO THE GROUND. IF YOUR POOL IS LEANING AT ALL, THE GROUND MAY NOT BE LEVEL AND YOU WILL NEED TO START OVER.**

**FAILURE TO FOLLOW THE INSTRUCTIONS ABOVE WILL CAUSE POOL TO COLLAPSE AND WILL VOID THE WARRANTY!**

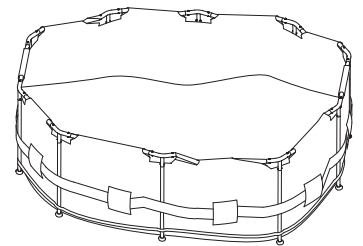

**IMPORTANT:** BEFORE ADDING WATER TO YOUR POOL YOU MUST INSTALL THE POOL WALL FITTINGS OR ENTIRE FILTRATION SYSTEM FIRST. BEFORE ADDING WATER TO YOUR POOL FOLLOW THE INSTRUCTIONS BELOW.

If your pool included openings or you are going to purchase a filter pump system, position the Suction & Return fitting locations so they are 10 to 21 feet from the electrical outlet you plan to use for the pool pump.

If your pool came with Fittings - Install both the Suction and Return fittings to the pool wall before filling the pool.

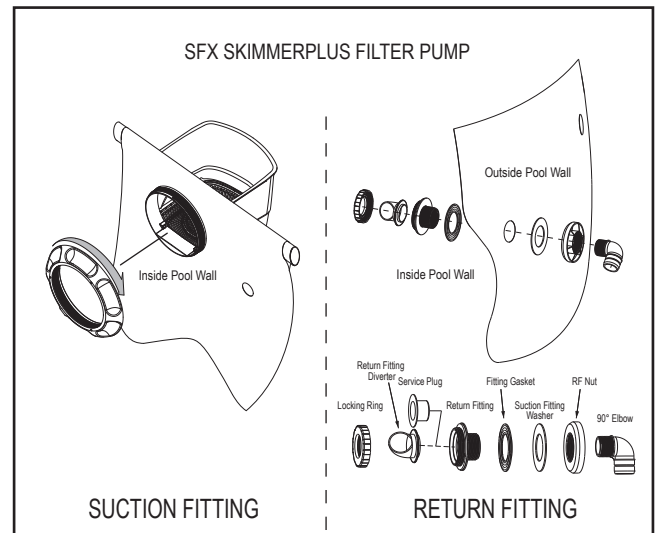
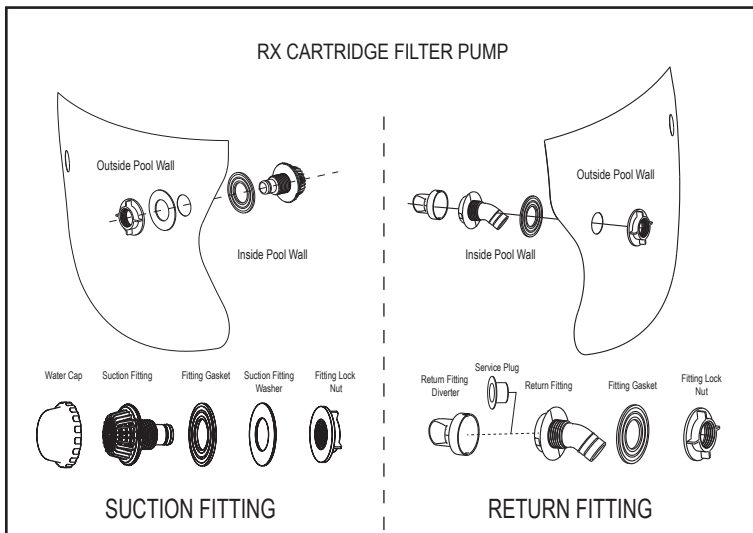

**NOTE:** For Sand Filter Pump / Cartridge Filter Pump CP2000-C, please follow the Sand Filter Pump / Cartridge Filter Pump CP2000-C owner's manual to set up the fitting. Please check the water pump's instruction manual for more instructions.

Please Note: The Black Rubber gasket (Fitting Gasket) should always be slid over the threaded plastic suction or return fitting and be on the inside before the fitting is placed through the pool wall to make a watertight connection.

Make sure to put on both the Water Cap and the Service Plug while you fill your pool, or until you are ready to add a filtration system.

## POOL MAINTENANCE & DRAINAGE

**CAUTION:** ALWAYS FOLLOW THE CHEMICAL MANUFACTURER'S DIRECTIONS, AND THE HEALTH AND HAZARD WARNINGS.

Do not add chemicals if the pool is occupied. This can cause skin or eye irritation. Concentrated chlorine solutions can damage the pool liner. In no event is Polygroup®, the buyer/retailers, or any other party liable for costs associated with the loss of pool water, chemicals, or water damage. Keep spare filter cartridges on hand. Replace cartridges every two weeks. We recommend the use of Polygroup® Filter Pump with all of our aboveground pools. To purchase a Polygroup® Filter Pump or other accessories, visit our website at [support.polygroupstore.com](http://support.polygroupstore.com) or call Polygroup® Consumer Services.

**EXCESSIVE RAIN:** To avoid damage to the pool and overfilling, immediately drain rain water that causes the water level to be higher than the FILL LINE.

### How to Drain Your Pool and Long Term Storage

1. Check local regulations for specific directions regarding disposal of swimming pool water.
2. Make sure the drain plug inside the pool is plugged in place.
3. Twist off the cap of the drain valve on the outside of the pool.
4. Attach a 5/8" garden hose to the drain valve.
5. Place the other end of the garden hose in an area where the water can be safely drained away from the house and other nearby structures.
6. Unplug the inner cap of the drain plug to start draining the pool.
7. When the water stops draining, start lifting the pool from the side opposite to the drain valve to drain any remaining water and empty the pool completely.
8. Replace the drain cap on outside of pool.
9. Remove all connecting parts.
10. Be sure that the pool and all parts are completely dry before storage. Air dry the liner in the sun until completely dry before folding (see drawing ①). Sprinkle some talcum powder to prevent the vinyl from sticking together and to absorb any residual moisture.
11. Create a square shape. Starting at one side, fold one-sixth of liner into itself twice. Do the same on the opposite side (see drawings ② & ③).
12. Once you have created two opposing folded sides, simply fold one over the other like closing a book (see drawings ④ & ⑤).
13. Fold the two long ends to the middle (see drawing ⑥).
14. Fold one over the other like closing a book, and finally compact the liner (see drawing ⑦).
15. Store the liner and accessories in a dry, temperature-controlled storage location above 32°F (0°C) and below 104°F (40°C).
16. The original packing can be used for storage.

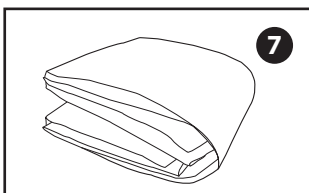
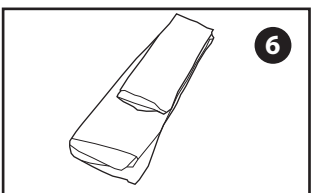
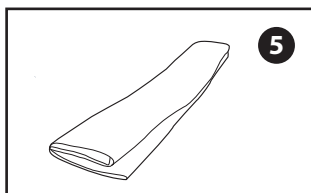
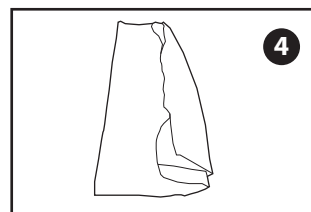
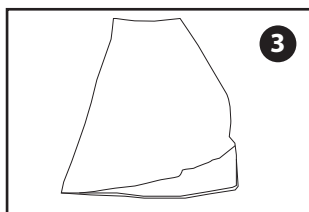
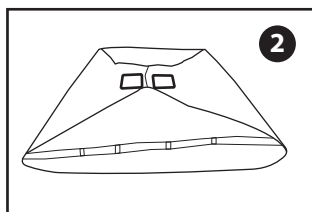
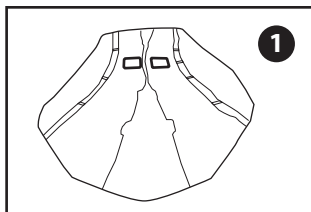

## POOL STORAGE & WINTERIZING

This above ground pool cannot be winterized and must be drained, disassembled, and properly stored if you live in an area where the temperature drops below 32°F (0°C). If you are in a warmer environment, please follow the instructions below.

After usage, you can easily empty and store away your pool in a safe place (see long term storage above). Some pool owners, in warmer climates however, may choose to leave their pool up all year round. In cold areas, where freezing temperatures occur, there can be a risk of ice damage to your pool. Leaving your above ground pool set up in areas where the temperature drops below 32 degrees Fahrenheit (0 Celsius) voids the warranty.

### Winterizing Your Above Ground Pool

1. Clean the pool water thoroughly.
2. Remove the skimmer (if applicable) or any accessories attached to the threaded strainer connector. Replace strainer grid if necessary. Be sure all accessories parts are clean and completely dry before storage.
3. Plug the Inlet and Outlet fitting from the inside of the pool (if applicable).
4. Remove the ladder (if applicable) and store in a safe place. Be sure the ladder is completely dry before storage.
5. Remove the hoses that connect the pump and filter to the pool.
6. Add the appropriate chemicals for the winter period. Consult your local pool dealer as to which chemicals you should use and how to use them. This can vary greatly by region.
7. Cover pool with Polygroup® Pool Cover. IMPORTANT NOTE: Polygroup® POOL COVER IS NOT A SAFETY COVER.
8. Clean and drain the pump, filter housing, and hoses. Remove and discard the old filter cartridge. Keep a spare cartridge for the next season.
9. Bring pump and filter parts indoors and store in a safe and dry area, preferably between 0°C (32°F) and 40°C (104°F).

## POOL SAFETY SIGN

POST THIS WARNING NEAR YOUR POOL



# WARNING

## NO DIVING OR JUMPING SHALLOW WATER

**DIVING MAY RESULT IN PERMANENT INJURY OR DEATH**



- Be Safe.
- Children must be accompanied by an adult.
- Don't swim when using alcohol or drugs.
- Be familiar with the pool before swimming.



- No running, jumping, or horseplay in or around pool.
- No glass in pool area.

**TO AVOID SERIOUS INJURY ALL POOL USERS MUST KNOW AND FOLLOW THESE SAFETY RULES.**

## POOL COVER SAFETY

IF YOU ARE GOING TO USE A POOL COVER, SOLAR COVER, OR SOLAR BLANKET, PLEASE READ THIS INFORMATION.

### POOL COVER WARNING / SOLAR COVER WARNING / SOLAR BLANKET WARNING

 **WARNING****AVOID DROWNING RISK**

STAY OFF THE COVER AND BLANKET - IT WILL NOT SUPPORT WEIGHT.

KEEP CHILDREN AWAY. CHILDREN OR OBJECTS CAN NOT BE SEEN UNDER COVER AND BLANKET.

REMOVE STANDING WATER - CHILDREN CAN DROWN ON TOP OF COVER.

REMOVE COVER AND BLANKET COMPLETELY BEFORE ENTRY OF SWIMMERS - ENTRAPMENT POSSIBLE.

NON-SECURED OR IMPROPERLY SECURED COVER AND BLANKET ARE A HAZARD.

FAILURE TO FOLLOW ALL INSTRUCTIONS MAY RESULT IN INJURY OR DROWNING.

THIS IS NOT A SAFETY COVER.

INSTALL COVER AND BLANKET WITH LABELS FACING UP.

USE DRAWSTRING TO SECURE COVER TO POOL. THIS COVER MEETS REQUIREMENTS DESCRIBED IN SPECIFICATION F-1346 (ASTM).

### VERY IMPORTANT

DO NOT USE A POOL COVER, SOLAR COVER, OR SOLAR BLANKET ON THIS POOL IF IT DOES NOT HAVE THIS TYPE OF WARNING LABEL ON THE COVER.

### DANGER:

Competent supervision and knowledge of the safety requirements are the only ways to prevent drowning or permanent injury in the use of this product!

Never leave young children unattended.